



Ürün Kataloğu  
Product Catalogue  
Каталог Продуктов



**VITAL GRUP**

COMPLETE ELEVATOR SYSTEMS

[www.vitalasansor.com](http://www.vitalasansor.com)

Sertifikalar | Certifications | Сертификаты

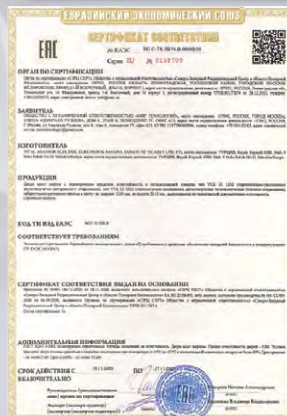
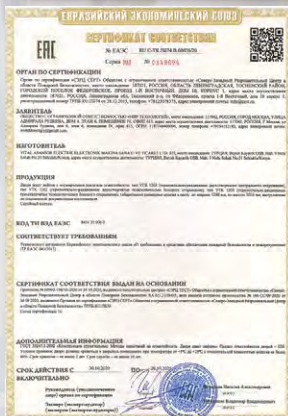

08-33

- Kabinler  
Cabins  
Кабины
- Panoramik Kabin  
Panoramic Cabin  
Панорамная кабина
- Hastane ve Yük Kabini  
Hospital & Freight Cabin  
Больничная и грузовая кабина
- Tavan Seçenekleri  
Ceiling Options  
Варианты потолка
- Taban Seçenekleri  
Ground Options  
Варианты пола
- Dekoratif Paslanmaz  
Decostyle Stainless  
Декоративная Нержавеющая
- Laminant Kaplama  
Laminete Plating  
Покрытие ламинатом
- Cam Kaplama  
Glass Plating  
Покрытие из стекла
- Süspansiyon Tipleri  
Suspension Type  
Типы подвески
- Karşı Ağırlık Şaseleri  
Counter-Weight Frame  
Подвески от противовеса

08  
24  
25  
26  
27  
28  
29  
30  
32  
33

# İçindekiler | Contents | Содержание



DOOR

36-63

Otomatik Kapı  
*Automatic Door*  
Автоматические двери

34

Kabin Kapısı  
*Cabin Doors*  
Двери Кабины

36

Kat Kapısı  
*Landing Doors*  
Этажные Двери

44

İç Güvenlik Kapısı  
*Semi-Automatic Doors*  
Мануальные двери

52

Manuel Kat Kapıları  
*Ceiling Options*  
Варианты потолка

61



PANO

64-69

Hazır Tesisat Sistemi  
*Prewired System Plug&Play*  
Готовая система управления

62

Kumanda Panoları  
*Control Panels*  
Панели управления

64



MAK

70-77

Butonlar  
*Buttons*  
Кнопки

68

Dişli Motorlar  
*MR Machine Engine*  
Редукторные моторы

70

Dişsiz Motorlar  
*MRL Machine Engine*  
Безредукторные моторы

71

Asansör Ekipmanları  
*Elevator Equipments*  
Лифтовое оборудование

72



LIFT

78-81

Homelift  
*Homelift*  
Лифт для дома

76

Servis Asansörü  
*Dumbwaiter Elevator*  
Сервисный лифт

77

Engelli Platformu  
*Platform For Disabled People*  
Платформа для инвалидов

78

Araç Asansörü  
*Vehicle Elevator*  
Автомобильные лифты

79



## Hakkımızda

VİTAL GRUP 2012 yılında kurularak faaliyetlerine başladı.

2019 yılından beri 13.000 m2 alanda faaliyetlerine devam eden firmamız **Avrupa, Amerika, Asya, Afrika ve Güney Amerika'da 70'den fazla ülkeye ihracat** yaparak, kaliteden ödün vermeden ve müşteri taleplerini dikkate alarak üretim kapasitesini artırmaya devam etmektedir.

Gelinen noktada, tesisimizde Asansör otomatik kapıları, Kabinler, Kabin süspansiyonları, Ağırlık şaseleri, Makine şaseleri, Kumanda panoları üretmekteyiz.

Proje odaklı çalışma esasına istinaden; Tarafımıza iletilen asansör taleplerini projelendirerek üretim aşamasına girmekte, projeye uygun üretimler tarafımızca yapılmakta, fabrikamızda üretilmeyen unsurlar tedarik edilerek, kalite kontrol sürecinden sonra müşteriye paket olarak sevk edilmektedir.

Firmamız müşterilerine daha kaliteli ve daha hızlı hizmet verebilmek için gerekli altyapı ve üretim standartlarını sürekli artırmaktadır. Üretimin her aşamasında ve üretim sonrası teknik desteğe son derece önem veren firmamız Ar-Ge çalışmalarına müşteri memnuniyetini dikkate alarak yön vermektedir.

VİTAL GRUP Kalite ve Güven odaklı prensiplerinden ödün vermeden sürdürdüğü bu yolda gelecekte de aynı şekilde hizmet vermeye devam edecektir.

## About Us

*VITAL GROUP was established in 2012 and started its activities.*

*Our company, which has been operating in an area of 13.000 m2 since 2019, continues to increase its production capacity by exporting to more than **70 countries in Europe, America, Asia, Africa and South America**, without sacrificing quality and taking customer demands into account.*

*At this point, we produce elevator automatic doors, cabins, cabin suspensions, c.weight chassis, machine chassis, control panels in our factory.*

*Based on the project-oriented work principle; It enters the production stage by designing the elevator requests submitted to us, the productions*



FEEL THE  
**PEAK**  
Zirveyi Hisset

*in accordance with the project are made by us, the elements that are not produced in our factory are supplied and shipped to the customer as a package after the quality control process.*

*Our company continuously increases the necessary infrastructure and production standards in order to provide better quality and faster service to its customers. Our company, which attaches great importance to technical support at every stage of production and after production, directs its R & D studies by taking customer satisfaction into account.*

*VITAL GROUP will continue to serve in the same way in the future in this way it continues without compromising its quality and trust oriented principles.*

#### О нас

Компания "ВИТАЛ" group была основана в 2012 году и начала свою деятельность.

Наша компания, которая работает на площади 13 000 м<sup>2</sup> с 2019 года, продолжает наращивать своё производство, экспортируя продукцию в более чем 70 стран Европы, Америки, Азии, Африки и Южной Америки без ущерба для качества и с учетом требований клиентов.

На данный момент мы производим автоматические двери лифта, кабины, подвески кабины, весовое шасси, шасси машины, панели управления на нашем предприятии.

Основываясь на проектно-ориентированной работе, мы входим в стадию производства, проектируя переданные нам запросы на лифт, производство в соответствии с проектом осуществляется нами, элементы, которые не производятся на нашем заводе, поставляются и отгружаются заказчику в упаковке после процесса контроля качества.

Наша компания постоянно повышает инфраструктуру и стандарты производства, необходимые для обеспечения более качественного и быстрого обслуживания своих клиентов. Наша компания, которая придает большое значение технической поддержке на каждом этапе производства и после производства, дает направление научно-исследовательским исследованиям с учетом удовлетворенности клиентов.

VITAL group будет продолжать служить таким же образом и в будущем на этом пути, который она продолжает, не ставя под угрозу свое качество и принципы, ориентированные на доверие.

# Dünya Üzerinde 78 Ülkeye İHRACAT...

AFGHANISTAN **GERMANY** ALBANIA **AUSTRIA**  
**AZERBAIJAN** BAHRAIN **BANGLADESH** BELGIUM  
**USA** BOSNIA AND HERZEGOVINA **BRAZIL** ULGARIA  
**ALGERIA** MOROCCO **PHILIPPINES** PALESTINE  
**FRANCE** SOUTH AFRICA REPUBLIC **SUDAN** GEORGIA  
**CROATIA** NETHERLANDS **IRAQ** ENGLAND **IRAN**  
KAZAKHISTAN **KENYA** KYRGYZSTAN **KOSOVO**  
KUWAIT LIBYA **LEBANON** HUNGARY **MACEDONIA**  
EGYPT **EGYPT** NIGER  
POLAND **COUNT**



**RUSSIA** SENEGAL **SER**  
/RIA **SAUDI ARAF**  
/THAILAND **TUNISI/**  
UKRAINE **OMAN** URUGU  
GHANISTAN **GERMANY** I  
N BAHRAIN **BANGLA**  
**ARAB EMIRATE**  
OVINA **BRAZIL** BU  
CO **PHILIPPINES** PA  
AFRICA REPUBLIC :

# OPERAT

GERMANY ALBANIA  
JAN BAHRAIN BANGLADESH  
OSNIA AND HERZEGOVINA RUSSIA UL  
ERIA MOROCCO PHILIPPINES PALES  
ANCE SOUTH AFRICA REPUBLIC SUDAN GEOR  
ROATIA NETHERLANDS IRAQ ENGLAND IRA  
AZAKHISTAN KENY UZBEKISTAN KOSOVO  
KUWAIT LIBYA LEBANON HUNGARY MACEDONIA  
MALAYSIA MALTA MEYAN YPT EGYPT NIGERIA  
UZBEKISTAN PAKI ISRAEL ISLAND COUNTRY  
ROMANIA SERBIA SINGAPORE  
SUDAN SYRIA S  
TANZANIA THAILA  
UGANDA UKRAINE  
GREECE ZAMBIA AFG  
USTRIA AZERBAIJAN BAHRAIN BANGLADESH BELGIUM  
UNITED ARAB EMIRATES BOSNIA AN  
HERZEGOVINA BRAZIL BULGARIA ALGER  
MOCCO PHILIPPINES PALESTINE FRAN  
AFRICA REPUBLIC SUDAN GE  
NETHERLANDS IRAQ



VITAL GRUP  
COMPLETE ELEVATOR SYSTEMS

VIPAR

VIDOOR

VIPANO

VIMAK

VILIFT





**MR (Machine-Room) Elevators** <

С Машинным Помещением Лифты  
Makine Daireli Asansörler

**MRL (Machine-Room-Less) Elevators** <

Без Машинного Помещения Лифты  
Makine Dairesiz Asansörler

**Hydraulic Elevators** <

Гидравлические Лифты  
Hidrolik Asansörler

Tavan | Ceiling | потолок



VR-01

Kaplama | Walls | Боковые



Dikey Döşeme  
Vertical Flooring

Zemin | Ground | Пол

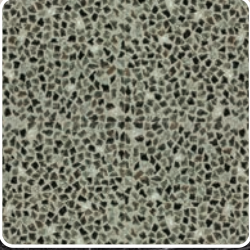

PVC 3717



ÖZELLİKLER | PROPERTIES | СВОЙСТВА

**TR** Arka Duvar : Tam boy ayna  
Tavan : Lazer kesim paslanmaz  
Taban : PVC  
Aksesuarlar : Ayna paslanmaz  
Yan Duvar : Satine Paslanmaz

**EN** Back Wall : Full mirror  
Ceiling : Laser cutting stainless  
Floor : PVC  
Accessories : Mirror stainless  
Side Wall : Satine Stainless

**RU** Задняя стенка : Зеркала на полный рост  
Потолок : Лазерная резка нержавеющей  
Основа : PVC  
Фурнитура : Зеркальное нержавейка  
Боковая стена : Декоративная нержавейка

# VC-02

Kabinler Cabins кабины

VITAL GRUP  
COMPLETE ELEVATOR SYSTEMS

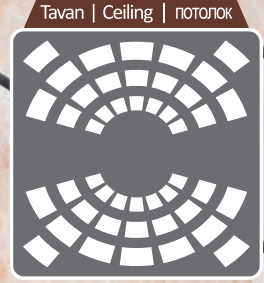

VR-10



Yatay döşeme  
Horizontal flooring



Aksaray Yaylak

VITAL GRUP



## ÖZELLİKLER | PROPERTIES | СВОЙСТВА

**TR** Arka Duvar : Tam boy ayna  
Tavan : Lazer kesim paslanmaz  
Taban : Doğal Granit  
Aksesuarlar : Ayna paslanmaz  
Yan Duvar : Dekoratif Paslanmaz

**EN** Back Wall : Full mirror  
Ceiling : Laser cutting stainless  
Floor : Natural granite  
Accessories : Mirror stainless  
Side Wall : Decorative Stainless

**RU** Задняя стенка : Зеркала на полный рост  
Потолок : Лазерная резка нержавеющей  
Основа : Натуральный Гранит  
Фурнитура : Зеркальное нержавеющейка  
Боковая стена : Декоративная нержавеющейка

Tavan | Ceiling | потолок



VR-15

Kaplama | Walls | Боковые



T-103 Gold

Zemin | Ground | Пол

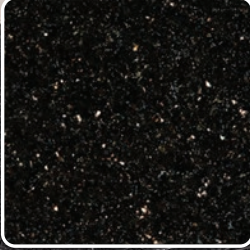

Star Galaxy



ÖZELLİKLER | PROPERTIES | СВОЙСТВА

**TR** Arka Duvar : Tam boy ayna  
Tavan : Lazer kesim paslanmaz  
Taban : Doğal Granit  
Aksesuarlar : Ayna paslanmaz  
Yan Duvar : Dekoratif altın paslanmaz

**EN** Back Wall : Full mirror  
Ceiling : Laser cutting stainless  
Floor : Natural granite  
Accessories : Mirror stainless  
Side Wall : Decorative gold stainless

**RU** Задняя стенка : Зеркала на полный рост  
Потолок : Лазерная резка нержавеющей  
Основа : Натуральный Гранит  
Фурнитура : Зеркальное нержавейка  
Боковая стена : Декоративная золота

# VC-04

Kabinler Cabins кабины

VITAL GRUP  
COMPLETE ELEVATOR SYSTEMS



Tavan | Ceiling | потолок



VR-23

Kaplama | Walls | Боковые



T-104 Copper

Zemin | Ground | Пол

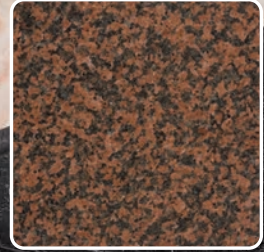

Multicolor Red

VITAL GRUP



ÖZELLİKLER | PROPERTIES | СВОЙСТВА

**TR** Arka Duvar : Tam boy ayna  
Tavan : Laser kesim paslanmaz  
Taban : Doğal Granit  
Aksesuarlar : Bakır paslanmaz  
Yan Duvar : Dekoratif bakır paslanmaz

**EN** Back Wall : Full mirror  
Ceiling : Laser cutting stainless  
Floor : Natural granite  
Accessories : Copper stainless  
Side Wall : Decorative copper stainless

**RU** Задняя стенка : Зеркала на полный рост  
Потолок : Лазерная резка нержавеющей  
Основа : Натуральный Гранит  
Фурнитура : Медь нержавеющей  
Боковая стена : Декоративная золота

Tavan | Ceiling | потолок

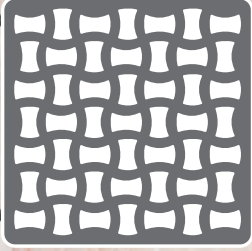

VR-24

Kaplama | Walls | Боковые



Doğal Taş | Natural Stone

Zemin | Ground | Пол

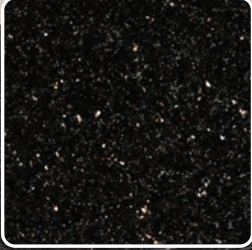

Star Galaxy



ÖZELLİKLER | PROPERTIES | СВОЙСТВА

**TR** **Arka Duvar** : Tam boy ayna  
**Tavan** : Lazer kesim paslanmaz  
**Taban** : Doğal Granit  
**Aksesuarlar** : Altın paslanmaz  
**Yan Duvar** : Dekoratif taş döşeme

**EN** **Back Wall** : Full mirror  
**Ceiling** : Laser cutting stainless  
**Floor** : Natural granite  
**Accessories** : Gold stainless  
**Side Wall** : Decorative stone flooring

**RU** **Задняя стенка** : Зеркала на полный рост  
**Потолок** : Лазерная резка нержавеющей  
**Основа** : Натуральный Гранит  
**Фурнитура** : Декоративная золота  
**Боковая стена** : Декоративная Натуральная Камень

# VC-06

Kabinler Cabins кабины



Tavan | Ceiling | потолок

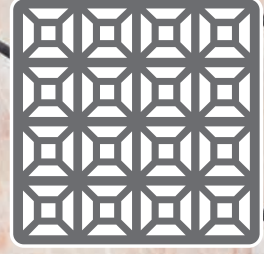

VR-03

Kaplama | Walls | Боковые



Doğal Taş | Natural Stone

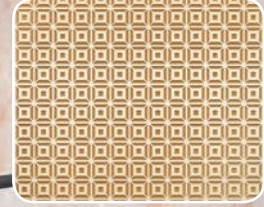

SG-283/DG-10

Zemin | Ground | Пол

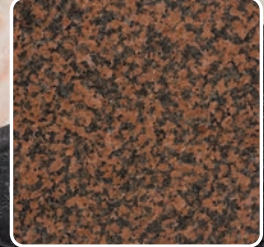

Multicolor Red

VITAL GRUP



## ÖZELLİKLER | PROPERTIES | СВОЙСТВА

**TR** Arka Duvar : Yarım boy ayna, dekoratif taş  
Tavan : Lazer kesim paslanmaz  
Taban : Doğal Granit  
Aksesuarlar : Altın paslanmaz  
Yan Duvar : Dekoratif altın paslanmaz

**EN** Back Wall : Half height mirror,  
Decorative stone  
Ceiling : Laser cutting stainless  
Floor : Natural granite  
Accessories : Gold stainless  
Side Wall : Decorative gold stainless

**RU** Задняя стенка : Зеркала на половину роста,  
Декоративный каменный  
Потолок : Лазерная резка нержавеющей  
Основа : Натуральный Гранит  
Фурнитура : Декоративная золота  
Боковая стена : Декоративная золота

Tavan | Ceiling | потолок

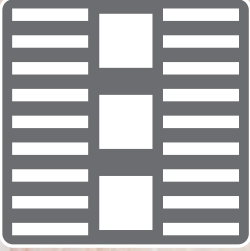

VR-18

Kaplama | Walls | Боковые

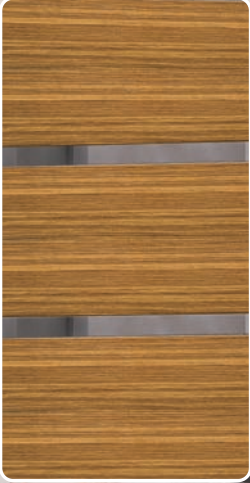

VL-076

Zemin | Ground | Пол

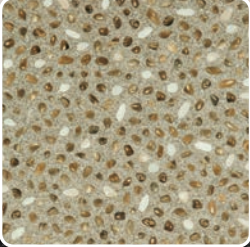

PVC ES-5



ÖZELLİKLER | PROPERTIES | СВОЙСТВА

**TR** Arka Duvar : Tam boy ayna  
Tavan : Lazer kesim paslanmaz  
Taban : PVC  
Aksesuarlar : Ayna paslanmaz  
Yan Duvar : Yatay döşeme laminant

**EN** Back Wall : Full mirror  
Ceiling : Laser cutting stainless  
Floor : PVC  
Accessories : Mirror stainless  
Side Wall : Horizontal flooring laminant

**RU** Задняя стенка : Зеркала на полный рост  
Потолок : Лазерная резка нержавеющей  
Основа : PVC  
Фурнитура : Зеркальное нержавейка  
Боковая стена : Горизонтальный пол ламинат



# VC-08

Kabinler Cabins кабины

VITAL GRUP  
COMPLETE ELEVATOR SYSTEMS



VR-21



VL-105

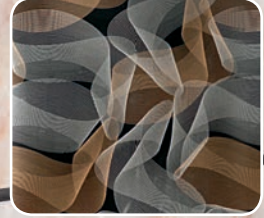

VL-107

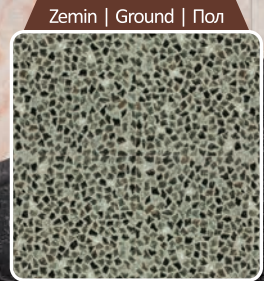

PVC 3717

VITAL GRUP



## ÖZELLİKLER | PROPERTIES | СВОЙСТВА

**TR** Arka Duvar : Yarım boy ayna  
Tavan : Laser kesim paslanmaz  
Taban : PVC  
Aksesuarlar : Ayna paslanmaz  
Yan Duvar : Yatay döşeme laminant

**EN** Back Wall : Half height mirror  
Ceiling : Laser cutting stainless  
Floor : PVC  
Accessories : Mirror stainless  
Side Wall : Horizontal flooring laminate

**RU** Задняя стенка : Зеркала на половину рост  
Потолок : Лазерная резка нержавеющей  
Основа : PVC  
Фурнитура : Зеркальное нержавейка  
Боковая стена : Горизонтальный пол ламинат

Tavan | Ceiling | потолок



VR-13

Kaplama | Walls | Боковые



Siyah Membran Kapak  
Black Membrane Finish

Zemin | Ground | Пол

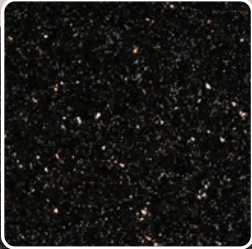

Star Galaxy



ÖZELLİKLER | PROPERTIES | СВОЙСТВА

**TR** Arka Duvar : Tam boy ayna  
Tavan : Lazer kesim paslanmaz  
Taban : Doğal granit  
Aksesuarlar : Ayna paslanmaz  
Yan Duvar : Özel MDF Lam

**EN** Back Wall : Full mirror  
Ceilling : Laser cutting stainless  
Floor : Natural granite  
Accessories : Mirror stainless  
Side Wall : Special MDF furnishing

**RU** Задняя стенка : Зеркала на полный рост  
Потолок : Лазерная резка нержавеющей  
Основа : Натуральный Гранит  
Фурнитура : Зеркальное нержавейка  
Боковая стена : МДФ с покрытием

# VC-10

Kabinler Cabins кабины

VITAL GRUP  
COMPLETE ELEVATOR SYSTEMS

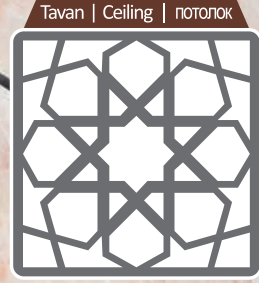

VR-12



Beyaz Membran Kapak  
White Membrane Finish



Bianco Perla



## ÖZELLİKLER | PROPERTIES | СВОЙСТВА

**TR** Arka Duvar : Yarım boy ayna  
Tavan : Lazer kesim paslanmaz  
Taban : Doğal granit  
Aksesuarlar : Altın paslanmaz  
Yan Duvar : Özel MDF Lam

**EN** Back Wall : Half height mirror  
Ceilling : Laser cutting stainless  
Floor : Natural granite  
Accessories : Gold stainless  
Side Wall : Special MDF furnishing

**RU** Задняя стенка : Зеркала на половину рост  
Потолок : Лазерная резка нержавеющей  
Основа : Натуральный Гранит  
Фурнитура : Зеркальное нержавеющейка  
Боковая стена : МДФ с покрытием

Tavan | Ceiling | потолок

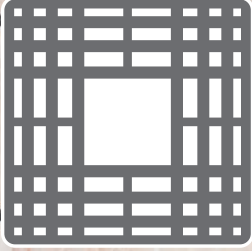

VR-07

Kaplama | Walls | Боковые

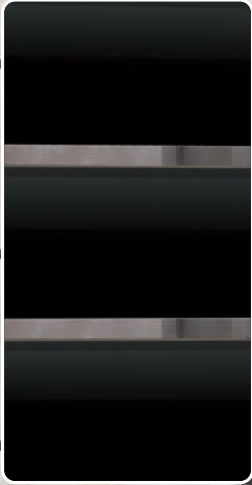

Emaye Siyah Cam  
Enamel Black Glass

Zemin | Ground | Пол



Star Galaxy



ÖZELLİKLER | PROPERTIES | СВОЙСТВА

**TR** **Arka Duvar** : Yarım boy ayna  
**Tavan** : Lazer kesim paslanmaz  
**Taban** : Doğal granit  
**Aksesuarlar** : Ayna paslanmaz  
**Yan Duvar** : Lamine cam

**EN** **Back Wall** : Half height mirror  
**Ceiling** : Laser cutting stainless  
**Floor** : Natural granite  
**Accessories** : Mirror stainless  
**Side Wall** : Laminate glass

**RU** **Задняя стенка** : Зеркала на половину роста  
**Потолок** : Лазерная резка нержавеющей  
**Основа** : Натуральный Гранит  
**Фурнитура** : Зеркальное нержавейка  
**Боковая стена** : Ламинированное стекло



Tavan | Ceiling | потолок



VG-301

Kaplama | Walls | Боковые



VG-123

Zemin | Ground | Пол



VF-09



ÖZELLİKLER | PROPERTIES | СВОЙСТВА

**TR** Arka Duvar : Tam boy ayna  
Tavan : Lamine cam  
Taban : Lamine cam  
Aksesuarlar : Ayna paslanmaz  
Yan Duvar : Lamine cam

**EN** Back Wall : Full mirror  
Ceilling : Lamine glass  
Floor : Lamine glass  
Accessories : Mirror stainless  
Side Wall : Lamine glass

**RU** Задняя стенка : Зеркала на полный рост  
Потолок : Ламинированное стекло  
Основа : Ламинированное стекло  
Фурнитура : Зеркальное нержавейка  
Боковая стена : Ламинированное стекло

Tavan | Ceiling | потолок



VR-14

Kaplama | Walls | Боковые

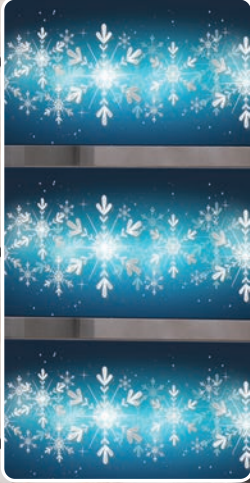

VG-204

Zemin | Ground | Пол

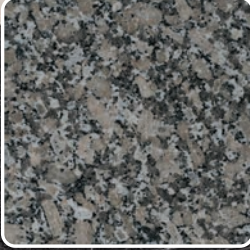

Rosa Minho



ÖZELLİKLER | PROPERTIES | СВОЙСТВА

**TR** Arka Duvar : Yarım boy ayna  
Tavan : Lazer kesim paslanmaz  
Taban : Doğal granit  
Aksesuarlar : Ayna paslanmaz  
Yan Duvar : Lamine cam

**EN** Back Wall : Half height mirror  
Ceiling : Laser cutting stainless  
Floor : Natural granite  
Accessories : Mirror stainless  
Side Wall : Lamine glass

**RU** Задняя стенка : Зеркала на половину рост  
Потолок : Лазерная резка нержавеющей  
Основа : Натуральный Гранит  
Фурнитура : Зеркальное нержавейка  
Боковая стена : Ламинированное стекло

# VC-14

Kabinler Cabins кабины

VITAL GRUP  
COMPLETE ELEVATOR SYSTEMS



VR-06



VG-109



VF-15

VITAL GRUP



## ÖZELLİKLER | PROPERTIES | СВОЙСТВА

**TR** Arka Duvar : Tam boy ayna  
Tavan : Lazer kesim paslanmaz  
Taban : Lamine cam  
Aksesuarlar : Altın paslanmaz  
Yan Duvar : Lamine cam

**EN** Back Wall : Full mirror  
Ceiling : Laser cutting stainless  
Floor : Laminate glass  
Accessories : Gold stainless  
Side Wall : Laminate glass

**RU** Задняя стенка : Зеркала на полный рост  
Потолок : Лазерная резка нержавеющей  
Основа : Ламинированное стекло  
Фурнитура : Декоративная золота  
Боковая стена : Ламинированное стекло

Tavan | Ceiling | потолок

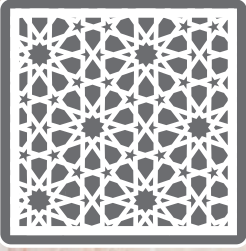

Lake seperatör  
Lacquer finish

Kaplama | Walls | Боковые

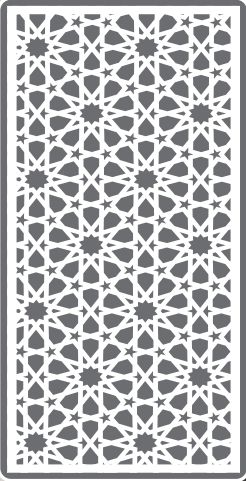

Lake seperatör  
Lacquer finish

Zemin | Ground | Пол



Star Galaxy



ÖZELLİKLER | PROPERTIES | СВОЙСТВА

**TR** Arka Duvar : Tam boy ayna  
Tavan : Lazer kesim paslanmaz  
Taban : Doğal granit  
Aksesuarlar : Altın paslanmaz  
Yan Duvar : Lake

**EN** Back Wall : Full mirror  
Ceiling : Laser cutting stainless  
Floor : Natural granite  
Accessories : Gold stainless  
Side Wall : Lacquer

**RU** Задняя стенка : Зеркала на полный рост  
Потолок : Лазерная резка нержавеющей  
Основа : Натуральный Гранит  
Фурнитура : Декоративная золота  
Боковая стена : Озеро



# VC-16

Kabinler Cabins кабины

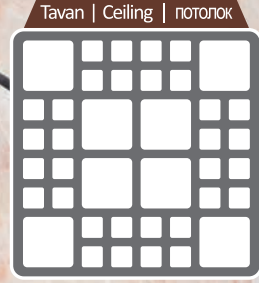

VR-09



Doğal Taş | Natural Stone



VL-252



Multicolor Red

VITAL GRUP



## ÖZELLİKLER | PROPERTIES | СВОЙСТВА

**TR** **Arka Duvar** : Yarım boy ayna,  
Dekoratif taş  
**Tavan** : Lazer kesim paslanmaz  
**Taban** : Doğal granit  
**Aksesuarlar** : Altın paslanmaz  
**Yan Duvar** : Laminant, altın paslanmaz

**EN** **Back Wall** : Half height mirror,  
Decorative stone  
**Ceiling** : Laser cutting stainless  
**Floor** : Natural granite  
**Accessories** : Gold stainless  
**Side Wall** : Laminate, gold stainless

**RU** **Задняя стенка** : Зеркала на половину роста,  
Декоративный каменный  
**Потолок** : Лазерная резка нержавеющей  
**Основа** : Натуральный Гранит  
**Фурнитура** : Декоративная золота  
**Боковая стена** : Ламинированное  
декоративная золота

Kare Panoramik Kabin  
Square Panoramic Cabin  
Полупанорамная кабина



VC-17

Oval Panoramik Kabin  
Round Panoramic Cabin  
Полностью панорамная кабина

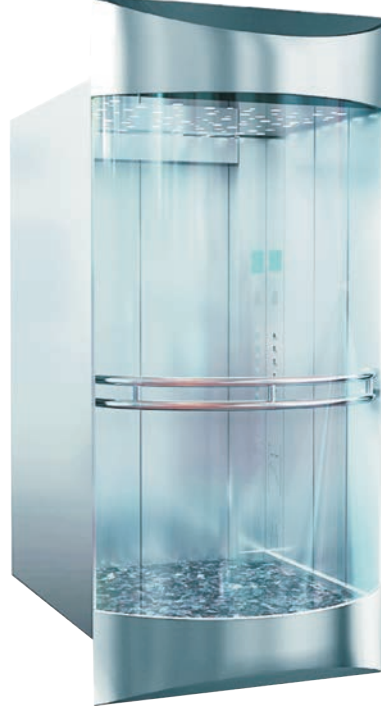

VC-18

#### ÖZELLİKLER

- 1,5 mm sac kabin duvarları
- AISI304 kalite paslanmaz çelik
- Hem iç hem dış paslanmaz kaplama
- Tamamı lazer kesimli parçalar
- Kolay montaj edilebilir yapı
- Extra mukavemet için teknik bükümler
- Farklı taban ve tavan seçenekleri
- Talep doğrultusunda yapılan özel uygulamalar

#### PROPERTIES

- 1,5 mm sheet metal cabin wall
- AISI304 quality stainless steel
- Both internal and external stainless coating
- All parts are laser cut
- Easy assembly structure
- Technical bends for extra strength
- Different floor and ceiling options
- Special applications made on request

#### Особенности

- Оцинкованный лист 1,5 мм
- Боковые стены из сатинированной нержавеющей стали
- Лазерная резка
- Зеркало в полурост
- Легко устанавливаемый поручень
- Освещение и вентиляция
- Пол из натурального гранита
- Различные варианты дизайна пола
- Опционально упаковка в ящики
- Специальные демпферы, предотвращающие вибрацию





VC-19



VC-20

#### ÖZELLİKLER

- 1,5 mm sac kabin duvarları
- ESB ral boya seçenekleri
- Paslanmaz kaplama seçenekleri
- Çarpma yumuşatıcı kuşaklar
- Tamamı lazer kesimli parçalar
- Kolay montaj edilebilir yapı
- Extra mukavemet için teknik bükümler
- Farklı taban ve tavan seçenekleri
- Talep doğrultusunda yapılan özel uygulamalar

#### PROPERTIES

- 1,5 mm sheet metal cabin wall
- ESB ral paint options
- Stainless coating options
- Impact softening band
- All parts are laser cut
- Easy assembly structure
- Technical bends for extra strength
- Different floor and ceiling options
- Special applications made on request

#### Особенности

- Оцинкованный лист 1,5 мм
- Электростатически окрашенные боковые стены
- Боковые стены из сатинированной нержавеющей стали
- Потолок с лазерной резкой
- Легко устанавливаемый поручень
- Освещение и вентиляция
- Пол из рифлёного алюминия
- Опционально упаковка в ящики
- Специальные демпферы, предотвращающие вибрацию

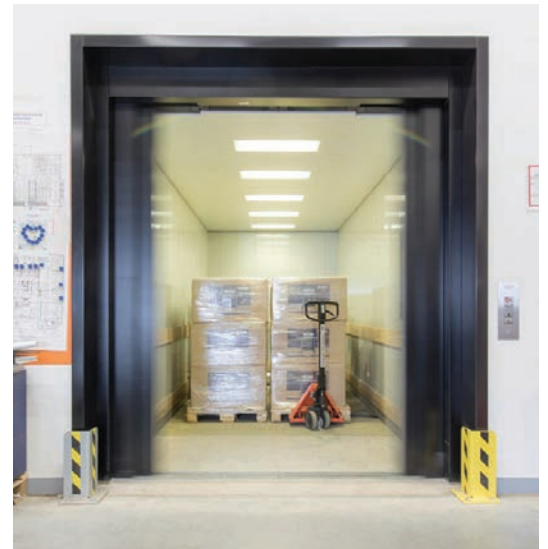



VR-01



VR-02

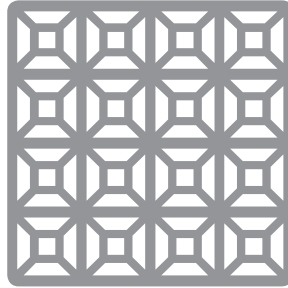

VR-03

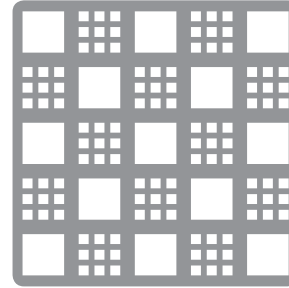

VR-04

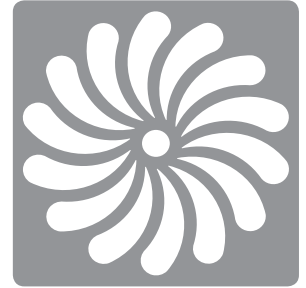

VR-05

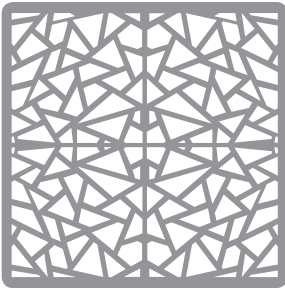

VR-06

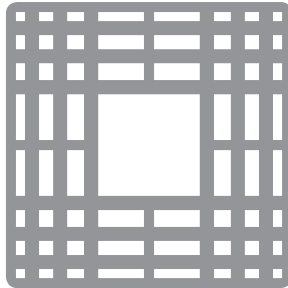

VR-07



VR-08

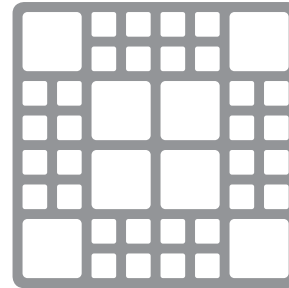

VR-09



VR-10

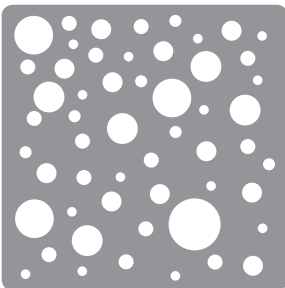

VR-11



VR-12



VR-13



VR-14

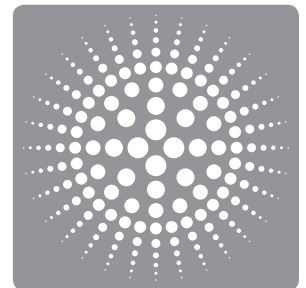

VR-15

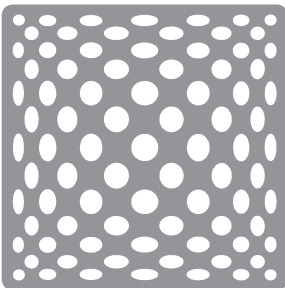

VR-16

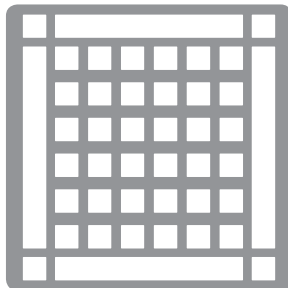

VR-17

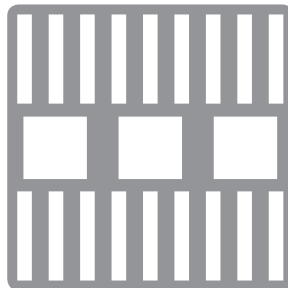

VR-18

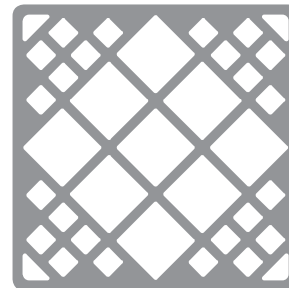

VR-19

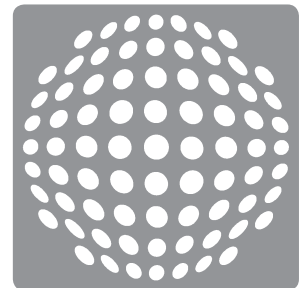

VR-20

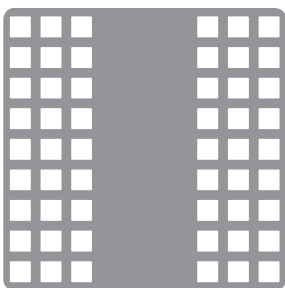

VR-21



VR-22



VR-23

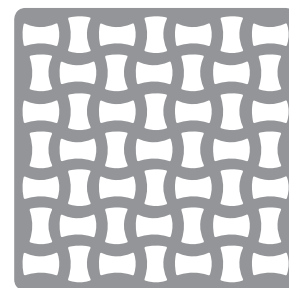

VR-24



VR-25

Granit | Granite | Гранит



Star Galaxy



Multicolor Red



Rosa Minho



Rosa Porrino

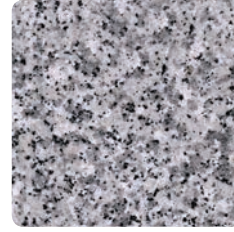

Bianco Perla



Aksaray Yaylak

PVC | PVC | ПВХ

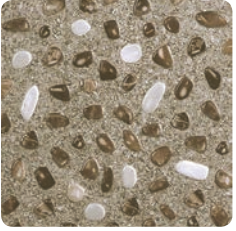

PVC-ES-5

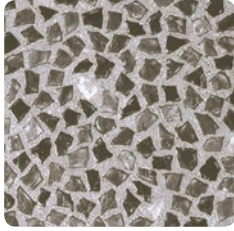

PVC-3714



PVC-1341



PVC-01



PVC-02



PVC-03



PVC-04



PVC-05



PVC-06



PVC-07

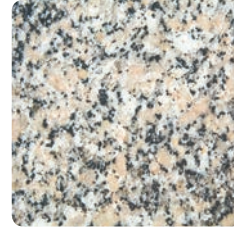

PVC-08

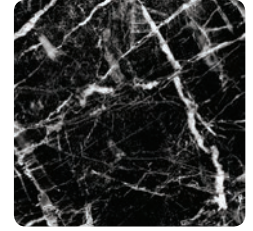

PVC-09

\* PVC-ES5, PVC-3714 ve PVC-1341 modelleri 450x450 mm karo şeklindedir. Diğer modeller 1500x1500 mm tek parça halindedir.

\* PVC-ES5, PVC-3714 and PVC-1341 models are 450x450 mm tile. Other models are 1500x1500 mm in one piece.

\* PVC-ES5, PVC-3714 и PVC-1341 модели 450x450 мм плитки. Другие модели 1500x1500 мм в одной части.

Cam | Glass | Стекло



VF-01

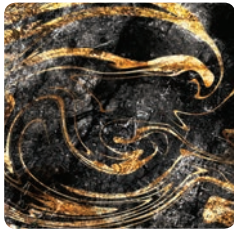

VF-02



VF-03

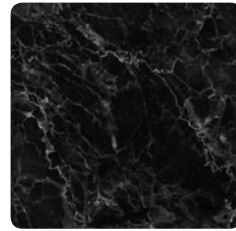

VF-04



VF-05

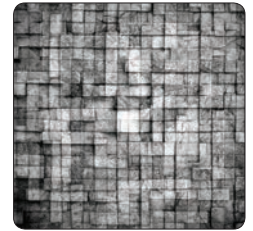

VF-06



VF-07



VF-08



VF-09



VF-10



VF-11



VF-12



VF-13



VF-14



VF-15

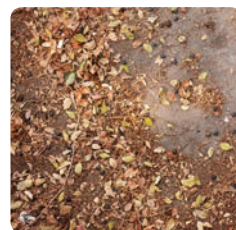

VF-16



VF-17



VF-18

V  
İ  
P  
A  
R



SG-218 DG-05

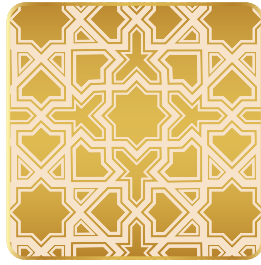

SG-223 DG-03



SG-226 DG-07

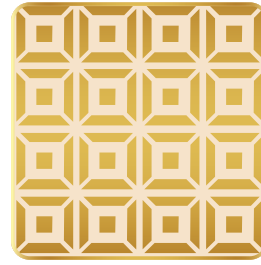

SG-238 DG-10



SG-288 DG-20



SM-118 DM-05



SM-123 DM-03



SM-126 DM-07

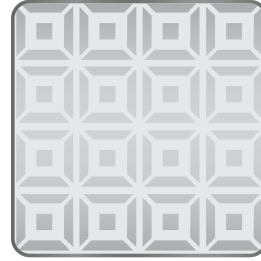

SM-138 DM-10



SM-188 DM-20



T-101 SILVER

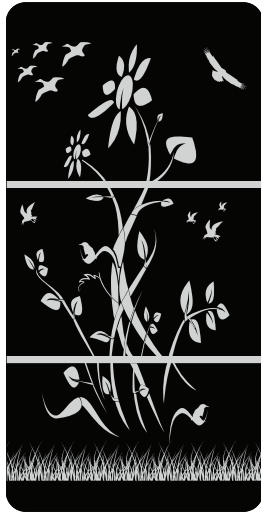

T-102 BLACK

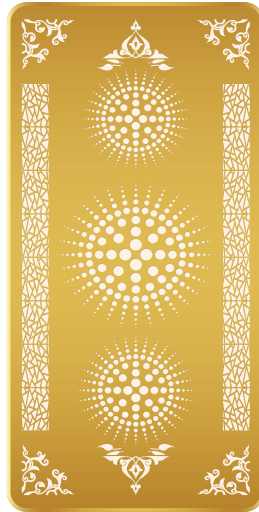

T-103 GOLD

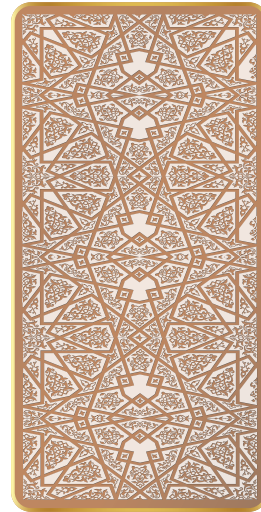

T-104 COPPER

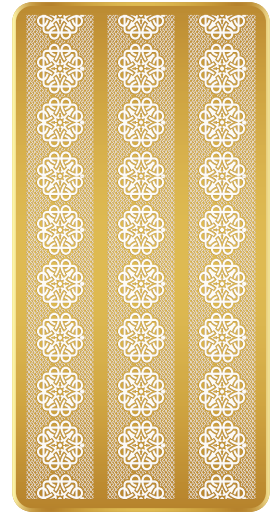

T-105 GOLD



T-106 BLACK



T-107 SILVER

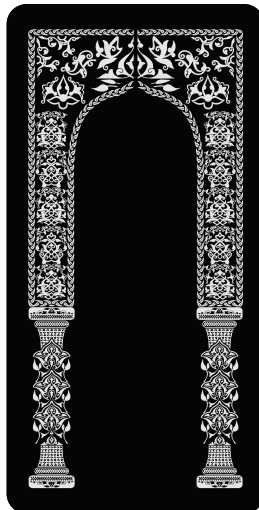

T-108 BLACK

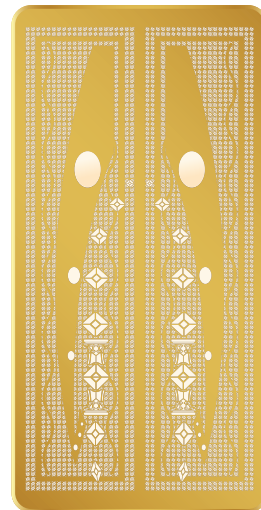

T-109 GOLD



SILVER



GOLD

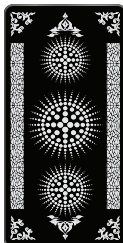

BLACK



COPPER



VL-105 P



VL-106 P

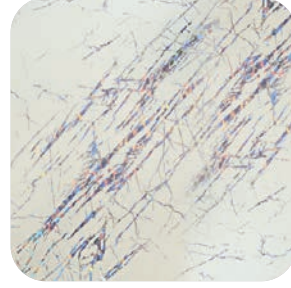

VL-610 P

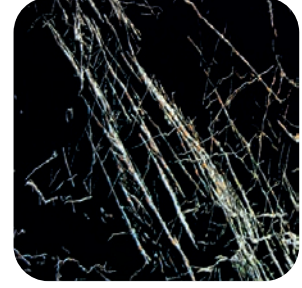

VL-612 P



VL-248 B



VL-250 B



VL-252 B



VL-065 B



VL-073 P



VL-076 P



VL-085 P



VL-093 P



VL-4208



VL-4267



VL-4428



VL-4513



VL-4514



VL-4523



VL-4544



VL-4605

P Kodlu laminatlar parlak yüzeyli, B kodlu laminatlar mat yüzeylidir.  
P Coded laminates with glossy surface, B-coded laminates have a matte surface.  
Ламинат с кодом P имеет глянцевую поверхность, Ламинат с кодом B имеет матовую поверхность.



VG-101

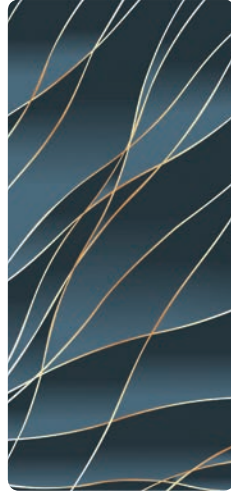

VG-102



VG-103

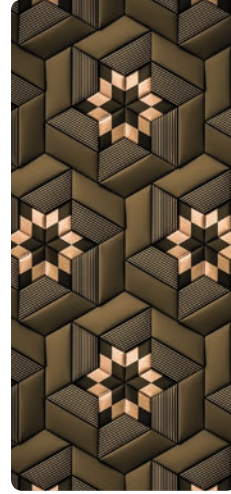

VG-104

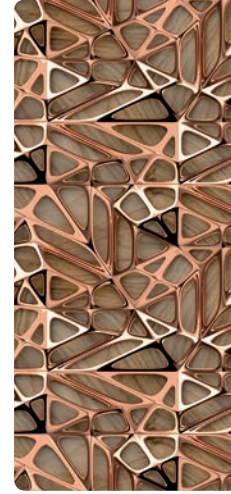

VG-105



VG-106

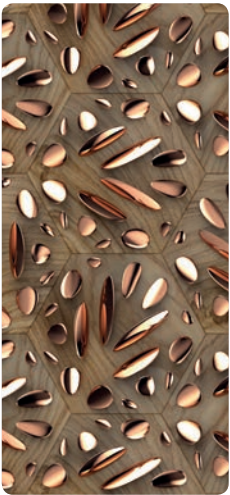

VG-107



VG-108



VG-109

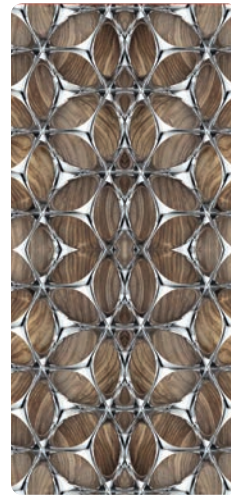

VG-110



VG-111



VG-112

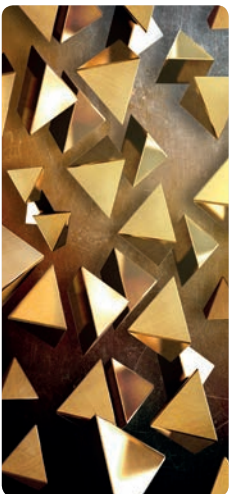

VG-113



VG-114



VG-115

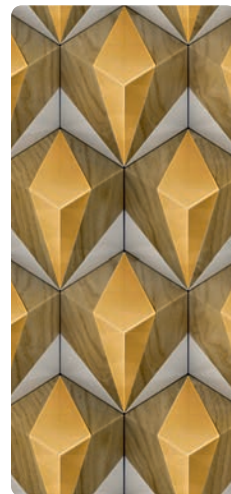

VG-116



VG-117



VG-118





VG-119



VG-120



VG-121



VG-122



VG-123



VG-124



VG-125



VG-126



VG-127



VG-128



VG-129



VG-130

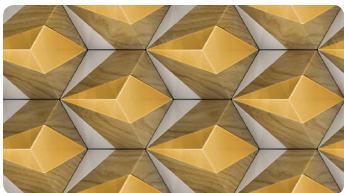

VG-201



VG-202

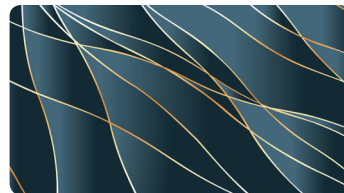

VG-203



VG-204

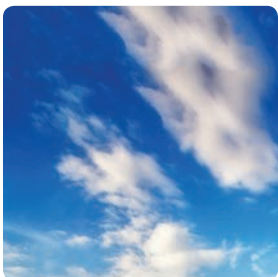

VG-301



VG-302



VG-303



VG-304

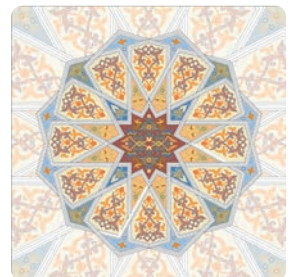

VG-305



MR 1:1 standart süspansiyon  
MR 1:1 standart car frame



MR 1:1 özel süspansiyon  
MR 1:1 special car frame



MRL 2:1 üstten T palanga  
MRL 2:1 top T traction



MRL 2:1 üstten palanga  
MRL 2:1 top traction



MRL 2:1 alttan palanga  
MRL 2:1 bottom traction



C ve L karkas tipleri  
C and L types frames



MR 1:1 Ağırlık Şasesi  
MR 1:1 Cwt. Frame



MRL 2:1 Ağırlık şaseleri  
MRL 2:1 Cwt. Frames



Çift sıra ağırlık şaseleri  
Double Row Cwt. frames



MR 1:1 Makine Sehpa  
MR 1:1 Machine Frame

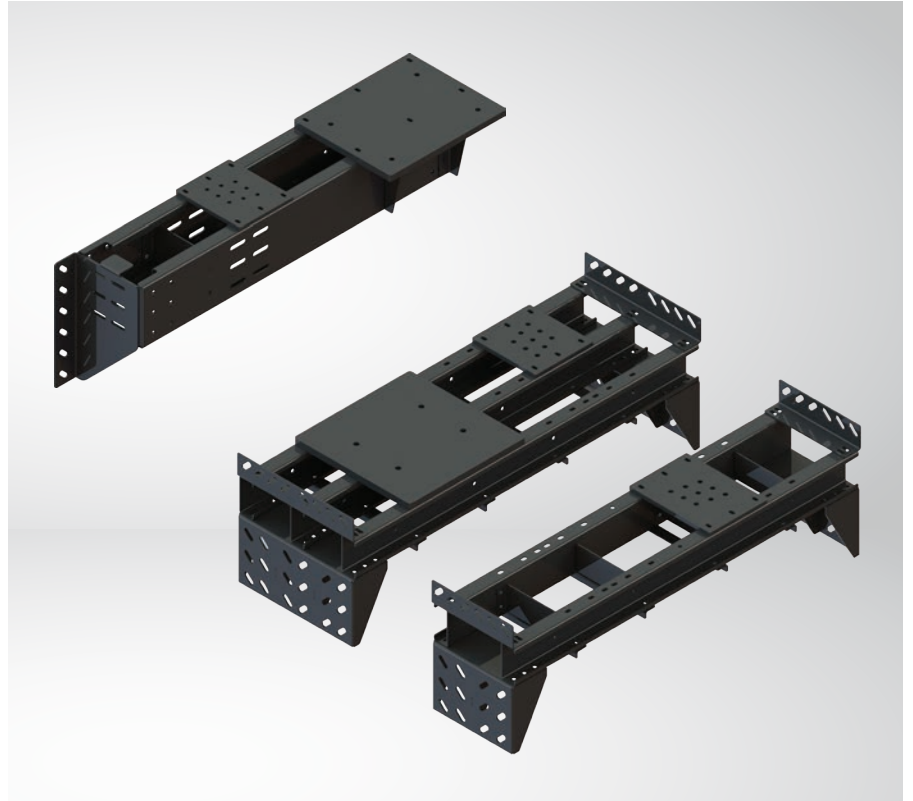

MRL 2:1 makine sehpaları, raya montaj / duvara montaj  
MRL 2:1 machine frames, rail mounting / wall mounting



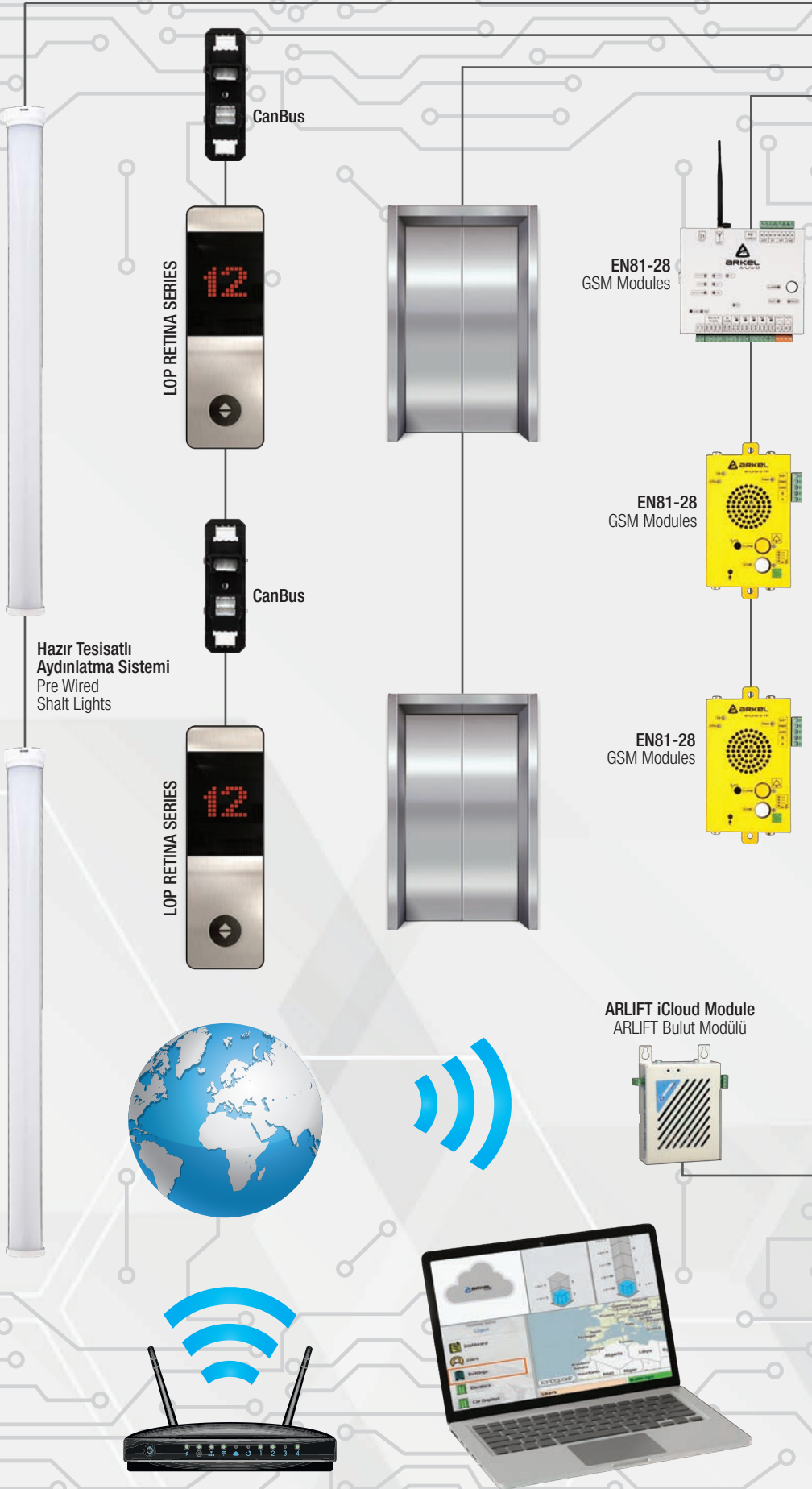

# PLUG PLAY

Akü Grubu  
Batteries For Emergency



Motor Acil Stop  
Emergency Stop



Dişlisiz Makine  
Gearless Machine



Regülör  
Overspeed Governor



AREM Terminal

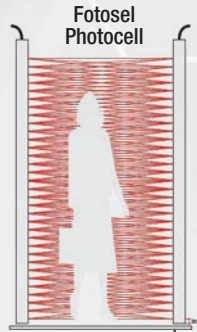

Fotosel  
Photocell

Lift Sense

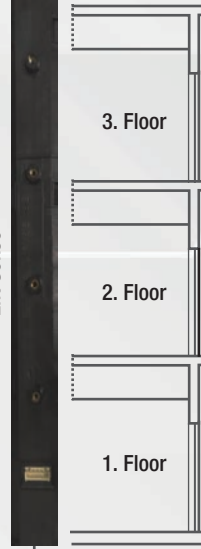

3. Floor

2. Floor

1. Floor



Makaralı Şalter  
Limit Switches



Makaralı Şalter  
Limit Switches



COP MEGA 7 SERIES

Overload Control Ünite  
Aşırı Yük Kontrol Ünitesi



Revision Box

Pit Box  
Kuyu Dibi Kutusu



Lightning Button



MR Motor Acil  
Emergency Stop



interkom



G&Z Plus  
Music Module



Flexible  
Attachment

Flexible  
Takoza



Flexible  
Takoza



Emergency  
Light



Buzzer

9x0,75 mm + 11x0,50 mm NYAF CABLE

# ARCODE

Dişlisiz Pano (MRL)  
Gearless Control Panel (MRL)  
БЕЗРЕДУКТОРНАЯ ПАНЕЛЬ УПРАВЛЕНИЕ



## ÖZELLİKLER

- EN 81-1/-2 +A3 ve En 81-20 Standartlarına uyumlu
- 64 Duraga kadar çalışabilme seçeneği
- Tahrik tipi asenkron ve senkron motorlar
- 5,5 KW 7.5 KW 11 KW 15 KW 22 KW 14-50 Amper güç seçeneği
- 8 Asansöre kadar grup çalışabilme özelliği
- Tek kapı ve çift otomatik kapı kontrolü
- 7 SEGMENT / GRAY-BINARY KOD / LCD gösterge çıkışı
- Türkçe, İngilizce, Rusça, Fransızca, Flemenkçe, İspanyolca, İsveççe, Lehçe, Almanca, Slovakça dil seçeneği
- Canbus ile seri haberleşme
- Kuyu boyunca kattan kata soketli kablolar ile eklemeli canbus hattı
- Kat butonierleri için hazır canbus haberleşmeli hazır tesisat sistemi
- Kabin butonierleri için hazır canbus haberleşmeli hazır tesisat sistemi
- EN81-20 Standartına uyumlu kuyu dibinden revizyon hareket kontrolü
- Çift kapı desteği ile duraklara göre bağımsız kapı kontrolü
- 1 FAZ 220V VE 60VDC Akü ile kolay yönde asansörü katına getirme özelliği
- Direkt duruş özelliği sayesinde kısa katlara çözüm sunabilme özelliği
- Motor Auto Tuning sayesinde motor tanıma özelliği
- Kabin pozisyon bilgisini arem el terminali üzerinden gözlemleyebilme
- Maksimum 4 M/SN ye kadar asansör hızı desteklemektedir.
- Darbe akım şalteri sayesinde kuyudan ve panodan kuyu aydınlatma kontrolü
- Dahili motor faz koruması.
- Opsiyonlar Liftsense, Arem El Terminali, G&Z Plus anons sistemi, Full hazır tesisat haberleşme

## PROPERTIES

- Compliant with EN 81-1 / -2 + A3 AND EN 81-20 standards
- Option to work up to -64 stops
- Drive type asynchono and synchronous motors
- 5.5 KW 7.5 KW 11 KW 15 KW 22 KW 14-50 Amper power option
- Group operation up to 8 lifts
- Single door and double automatic door control
- 7 Segment / Gray-Binary Code / LCD display output
- Turkish, English, Russian, French, Flemench, Spanish, Sweden, Polish, German, Slovak Language Option
- Serial communication with canbus
- Canbus line added with socket cables long the well from floor to floor
- Pready installation system with canbus communication for floor buttons
- Ready installation system with canbus communication for cabin button
- Well bottom revision movement control compatible with EN81-20 standard
- Independent door control according to the stops with double door support easy To Floor The Elevator With 1 phase 220V and 60 VDC battery
- Solutions to short floors due to the direct stop feature
- Motor recognition and well recognition feature thanks to motor auto tuning
- Observing the position information of the cabin on the arem hand terminal Support elevator speed up to 4 m/ sec.
- Well lighting control from well and panel thanks to impact current switch
- Internal motor phase protection.
- Options if liftsens, arem hand terminal, G & Z plus announcement system, full ready installation communication

## Функции

- Соответствует стандартам EN 81-1 / -2 + A3 и En 81-20
- Возможность работать до 64 остановок
- Тип привода асинхронные и синхронные двигатели
- 5,5 кВт 7,5 кВт 11 кВт 15 кВт 22 кВт 14-50 ампер вариант мощности
- Возможность работы в группах до 8 лифтов.
- Управление одной дверью и двойной автоматической дверью
- 7 СЕГМЕНТ / СЕРЫЙ-ДВОИЧНЫЙ КОД / ЖК-индикатор выход
- Варианты языков на турецком, английском, русском, французском, голландском, испанском, шведском, польском, немецком, словацком
- Последовательная связь с Canbus
- Проложенная линия канбуса вдоль колодца с кабелями в гнездах от пола до этажа
- Готовая система установки с готовой коммуникацией по шине CAN для напольных кнопок
- Готовая система электропроводки с готовой связью CANBUS для места кнопки автомобиля
- Ревизионное управление движением со дна колодца в соответствии со стандартом EN81-20
- Независимое управление воротами по упорам с двухстворчатой опорой
- Возможность поднять лифт на этаж в удобном направлении с 1-фазной батареей 220 В и 60 В постоянного тока.
- Возможность предлагать решения для коротких полов благодаря прямому расположению
- Функция распознавания двигателя благодаря Motor Auto Tuning
- Возможность наблюдать за информацией о местоположении контейнера на территории терминала
- Он поддерживает максимальную скорость лифта 4 м / с.
- Управление освещением колодца с колодца и пульта с помощью переключателя импульсного тока
- Внутренняя фазовая защита двигателя.
- Опции Liftsense, портативный терминал Arem, система оповещения G&Z Plus, коммуникация по полной установке

**Dişlili Pano (MR)**  
Geared Control Panel (MR)  
Редукторная Панель Управление



**Seri Tesisat Revizyon Kutusu IBC-S**  
Serial Installation Revision Box IBC-S  
Ревизионная установка для серийной установки IBC-S

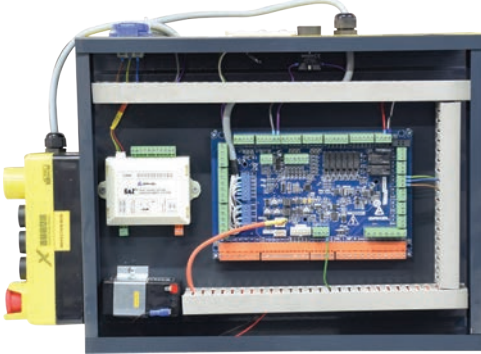

**Paralel Tesisat Revizyon Kutusu FXCAN**  
Parallel Installation Revision Box FXCAN  
Параллельной установка для серийной установки FXCAN

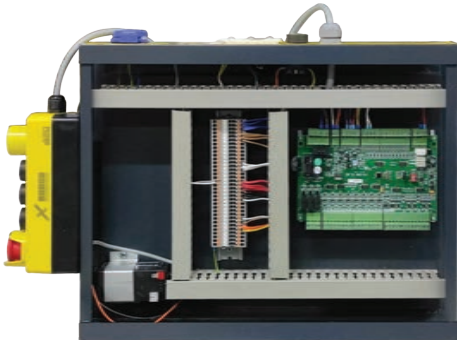

**Kuyu Dibi Revizyon Kutusu**  
Pit Box  
ревизионного аппарат



**EI Terminali | AREM Terminal | Программатор**



**ARLINE Uzaktan İzleme, Alarm ve İnterkom Sistemi**  
ARLINE System | Система ARLINE



Pano Gsm Haberleşme  
ARLINE-S-INT



Gsm Pano Modülü  
ARLINE-M



Kuyu Kabin Üstü Haberleşme  
ARLINE-S-TP

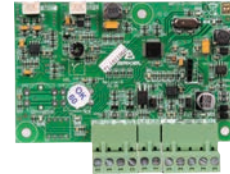

Kabin Kasedi Gsm Haberleşme  
ARLINE-S-COP

**G&Z Plus Music Module**

**ARLIFT**



Liftsense





# A Drive

## ÖZELLİKLER

- EN 81-1/-2 +A3 standartına uyumlu
- 24 Durağa kadar çalışabilme seçeneği
- Tahrik tipi asenkron ve senkron motorlar
- 5.5 KW, 7.5 KW, 11 KW, 15 KW, 22 KW, 14-50 Amper aralığında güç seçeneği
- 4 Asansöre kadar grup çalışabilme özelliği
- Yarı otomatik kapı, tek kapı ve çift otomatik kapı kontrolü
- 7 SEGMENT / GRAY-BINARY KOD / LCD Gösterge çıkışı
- Türkçe, İngilizce, Rusça, Hollandaca, Romence, Almanca, İtalyanca dil seçeneği
- 1 FAZ 220V veya 60 VDC Akü ile kolay yönde asansörü katına getirme özelliği
- Motor Auto Tuning sayesinde motor tanıma özelliği
- Maksimum 1,6 M/SN'ye kadar asansör hızı desteklemektedir.
- Dahili motor faz koruması.
- 16 ve 32 Duraga kadar seri haberleşme ile revizyon kutusu desteği
- G&Z Plus sayesinde asansör ses & Anons kontrolü (opsiyonlu)
- Kapı erken açma ve kapı açık seviyeleme
- Kabin içerisinden kat ayarı

## PROPERTIES

- Compliant with EN 81-1 / -2 + A3 standard
- Option of working up to 24 stops
- Drive type asynchono and synchronous motors
- 5.5KW 7.5KW 11KW 15KW 22KW 14-50 amper power selection
- Group operation up to 4 lifts
- Semi automatic door, single door and double automatic door control
- 7 Segment / Gray-Binary Code / LCD display output
- Turkish, English, Russian, Dutch, Romanian, German, Italian language options
- Easy to floor the elevator with 1 phase 220 V or 60 VDC battery
- Motor recognition and well recognition feature thanks to motor auto tuning support elevator speed up to 1.6 m / Sec.
- Internal Motor Phase Protection.
- Revision box support with serial communication up to -16 and 32 duraga
- Elevator sound & announcement control thanks to G & Z plus (optional)
- Door opening early and leveling the door open
- Floor adjustment from inside the cabin

## Функции

- Соответствует стандарту EN 81-1 / -2 + A3
- Возможность работать до 24 остановок
- Тип привода асинхронные и синхронные двигатели
- 5,5 кВт, 7,5 кВт, 11 кВт, 15 кВт, 22 кВт, вариант мощности 14-50 ампер
- Возможность работы в группах до 4-х лифтов.
- Полуавтоматическая дверь, одинарная дверь и двойное автоматическое управление дверью
- 7 СЕГМЕНТНЫЙ / СЕРЫЙ-БИНАРНЫЙ КОД / ЖК-дисплей Выход индикатора
- Варианты языков: турецкий, английский, русский, голландский, румынский, немецкий, итальянский
- Возможность поднять лифт на этаж в удобном направлении с 1 ФАЗНОЙ батареей 220 В или 60 В постоянного тока
- Функция распознавания двигателя благодаря Motor Auto Tuning
- Он поддерживает максимальную скорость лифта 1,6 м / с.
- Внутренняя фазовая защита двигателя.
- Поддержка редакцияного бокса с последовательной связью до 16 и 32 Dura
- Аудиосистема лифта и управление объявлениями (опционально) благодаря G&Z Plus
- Раннее открытие двери и выравнивание открытия двери
- Регулировка пола внутри кабины

Dişlisiz Pano (MRL)  
Gearless Control Panel (MRL)  
БЕЗРЕДУКТОРНАЯ ПАНЕЛЬ УПРАВЛЕНИЕ



Dişli Pano (MR)  
Geared Control Panel (MR)  
Редукторная Панель Управление



Revizyon Kutusu  
Revision Box  
Ревизионная коробка

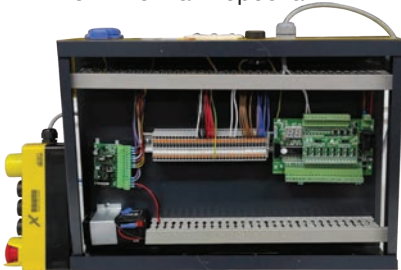

# ARCUBE



## Genel Özellikleri

- VVVF sürücü, kontrol kartı, kurtarma fonksiyonu ve diğer elektrik şalt malzemeleri tek bir monoblok ünite
- STO fonksiyonlu kontaktörsüz tasarım
- Hafif, küçük boyut ve kolay kurulum özelliği
- EN 81-20 standartlarına uyumlu
- Azaltılmış seyahat kablosu ile düşük maliyet
- Direkt duruş özelliği
- Senkron ve asenkron makineler ile çalışabilme özelliği
- Açık ve kapalı çevrim çalışma özelliği
- Dayanıklı ve uzun ömürlü
- Enerji Tasarrufu

## Функции

- Драйвер VVVF, карта управления, функция спасения и другое электрическое распределительное устройство в одном моноблочном блоке
- Бесконтактная конструкция с функцией STO
- Легкий вес, небольшие размеры и простая установка
- Соответствует стандартам EN 81-20
- Низкая стоимость с уменьшенным ходовым кабелем
- Особенность прямой стойки
- Умение работать с синхронными и асинхронными машинами.
- Функция работы с разомкнутым и замкнутым контуром
- Прочный и долгий срок службы
- Сохранение энергии

## Features

- Combines VVVF drive unit, control board, rescue function and other electrical components in a single monoblock unit
- Contactorless design with STO function
- Small, lightweight and ready to install
- Compatible with EN 81-20 standards
- Decreased costs due to less traveling cable requirements
- Direct landing
- Ability to work with synchronous and asynchronous machines
- Ability to work open and close loop
- Reliable and industrialized
- Energy saving

## Teknik Özellikler:

- Durak Sayısı: 16
- Tesisat: Kabin ve kat butonierleri ile seri veya paralel bağlantı imkanı ve Arcode uyumlu seri tesisat birimleri
- Kapı Köprüleme: Mevcut
- Kumanda Tipi: Tek Buton Toplama, Çift Buton Toplama
- Asansör Hızı: 1.75 m/s
- Standart Uygunluk: EN 81-20
- Tahrik Tipi: Elektrikli
- Kabin Pozisyon Bilgisi: Manyetik Şalter ya da motor enkoderi
- Modeller: 4kW(10A)-5.5kW(14A)-7.5kW(17A)-11kW(26A)
- Grup Kumanda: Dupleks
- Motor Sürme Tipi: STO fonksiyonlu kontaktörsüz sürüş
- Kalkış Tutma: Ön-tork ve kalkış tutma fonksiyonları ile kalkışta geri kaymayı önleme

## T

- Number of Stops : 16
- Cabling: Serial or parallel connection options with Lopls and COP's Arcode compatible serial communication unit
- Door Bridging: Available
- Control Type: Single button collective, Double button collective
- Elevator Speed: 1.75 m/s
- Compliance to Standards: EN 81-20
- Drive Type: Traction
- Car Positioning: Magnetic switches or motor encoder
- Models: 4kW(10A)-5.5kW(14A)-7.5kW(17A)-11kW(26A)
- Group Control: Duplex
- Motor Drive Type: Contactorless drive with STO function
- Rollback Prevention: Rollback prevention at start through pre-torque and anti-rollback functions

## Технические характеристики

- Количество остановок: 16
- Установка: возможность последовательного или параллельного подключения с кнопками автомобиля и пола и последовательными установочными блоками, совместимыми с Arcode
- Переключатель двери: Доступна
- Тип управления: Коллекция с одной кнопкой, Коллекция с двумя кнопками
- Скорость лифта: 1,75 м / с
- Соответствие стандартам: EN 81-20
- Тип привода: электрический
- Информация о положении в кабине: магнитный переключатель или датчик двигателя
- Модели: 4 кВт (10 А) -5,5 кВт (14 А) -7,5 кВт (17 А) -11 кВт (26 А)
- Групповое управление: дуплекс
- Тип привода двигателя: бесконтактное вождение с функцией STO
- Удержание при запуске: функции предварительного крутящего момента и удержания при взлете для предотвращения отката во время взлета.



RN4110D



41B0



RN1012



RN1072



1082



1072



1012



931-MEGA7V-DM



932-MEGA7V-DM



932 CDD

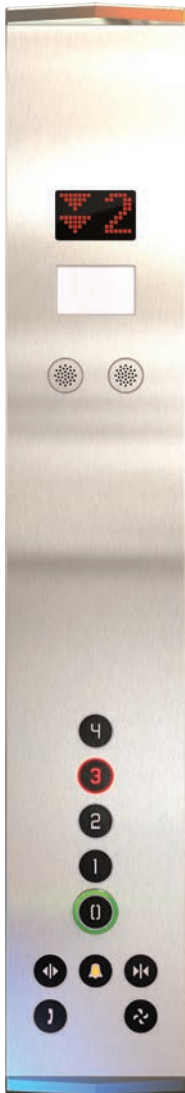

731-CDD



733-CDD



732-MEGA7V-DM





LGPN2000TF7



ASB 5000 B1



ASB 5000 B2

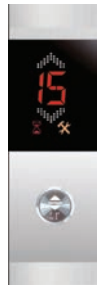

PST281



SGT321



SXGT261\_01



PSXT251



ELEGANCE-S6



VARIANT-S1



PGI280



GIA250-LCD



LSPN1000SM

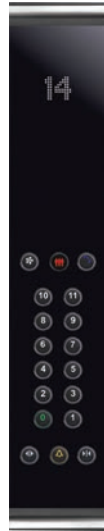

PGN1000SM



PGT2822



PST2822



SGTP322



SGT322\_01



LSPNY1000



U21TM0003



U21TM0001



U21TM0006



U20SM0016



U26SM0001



U28SM0001



U20SM0010



U20DB0002



U21YR0001



U21YR0003



U21YR0005



U20KU0004



U20KU0003



U26DB0002



U21YT001

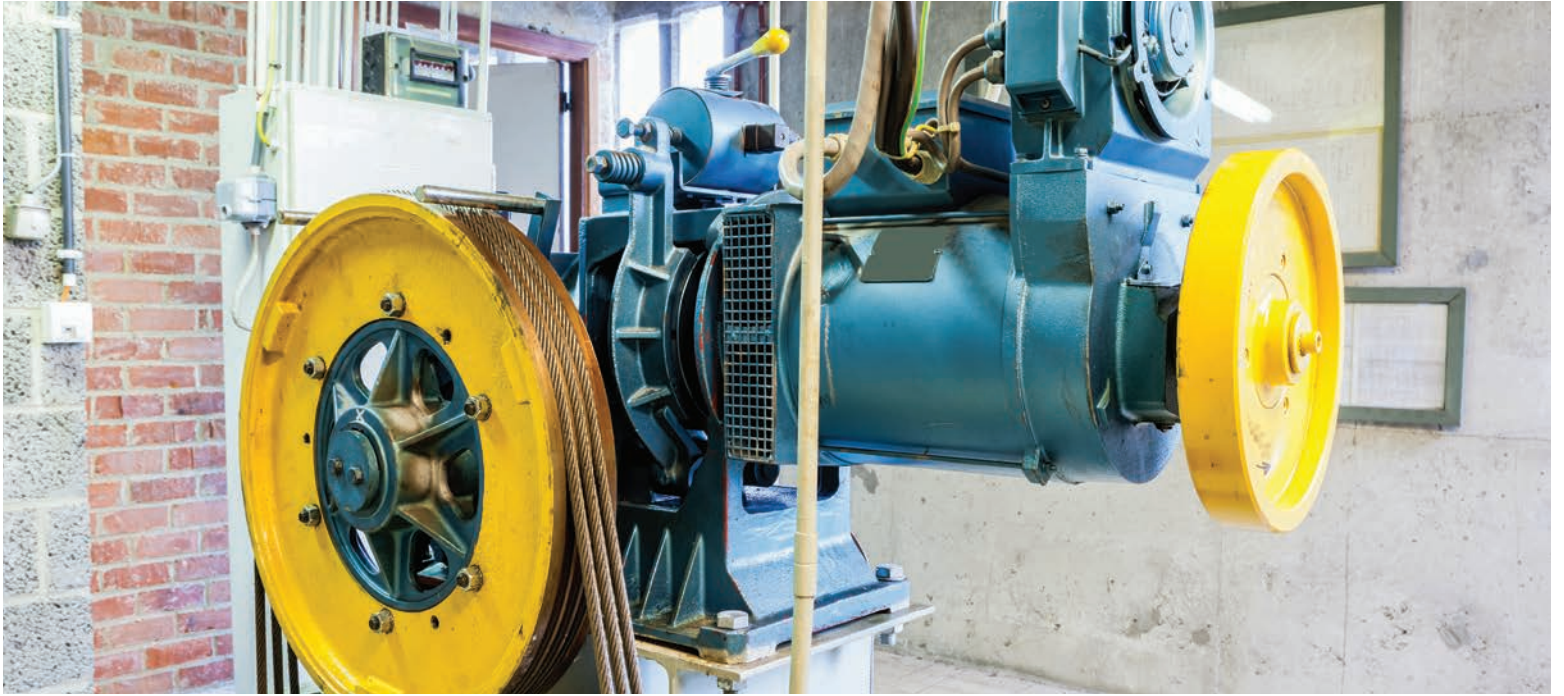

AKIŞ ZF



AKIŞ VOLPI



AKIŞ MUGEN



EKER FORCE



EKER SMART



EKER STRONG LITE



EKER STRONG PLUS



EKER STRONG



MONTANARI MR



TOPGEARS ITG



ALBERTO SASSI



SICOR MR



AKIŞ AK



AKIŞ VOLPI



AKIŞ S



EKER QUITE



MONTANARI MGV



LAFERT T24



ALBERTO SASSI G

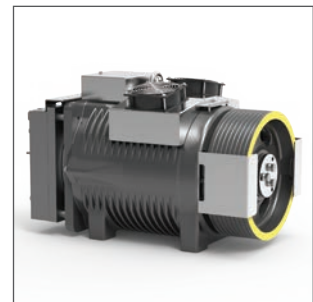

SICOR SG



SICOR SGS



ZIEHL-ABEGG ZATOP



WITTUR WSG



EMF SQML

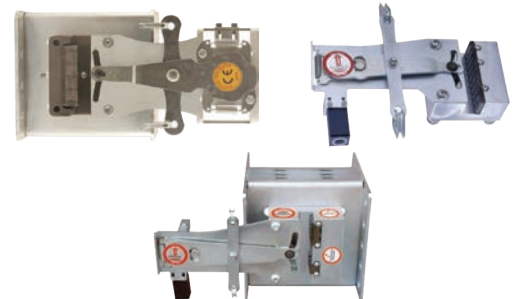
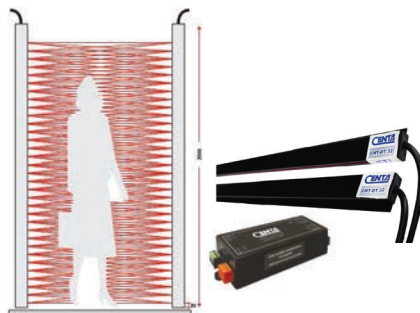
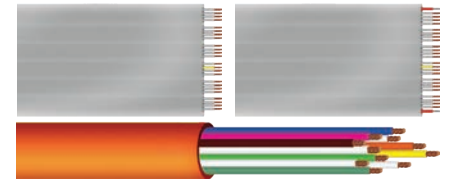

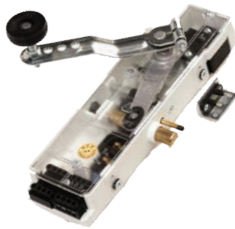
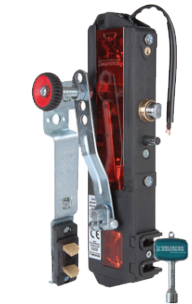



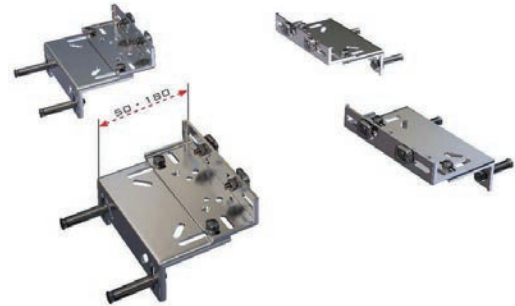
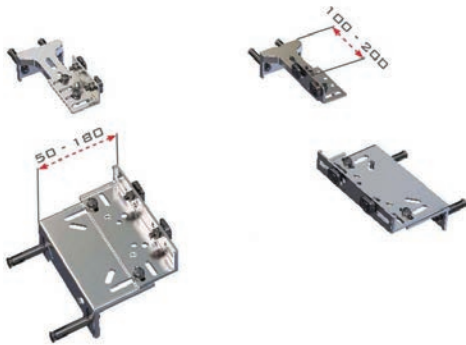

MAK

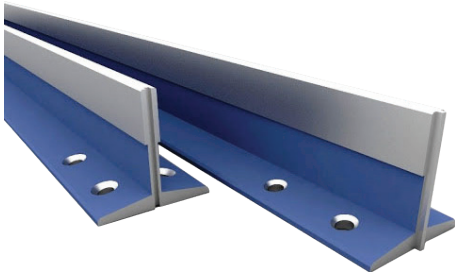
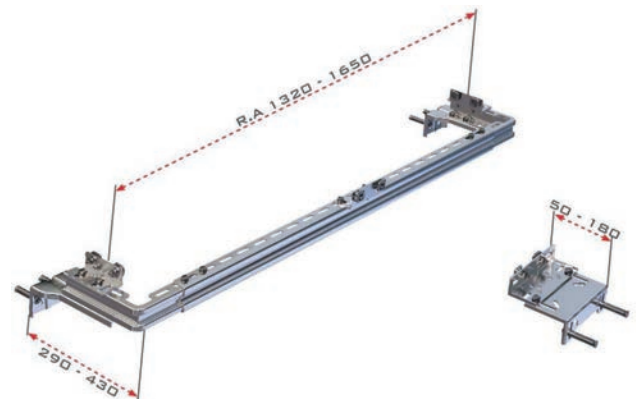
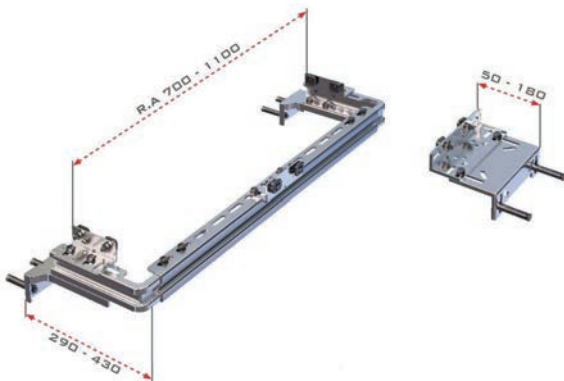

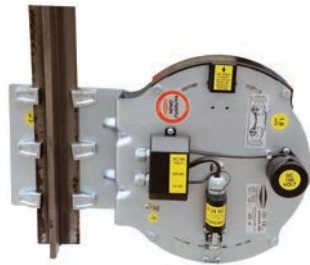
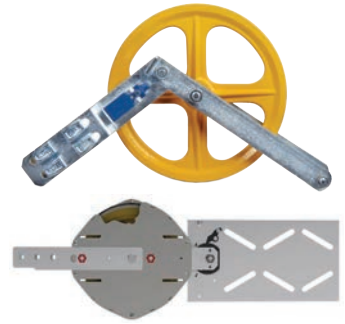

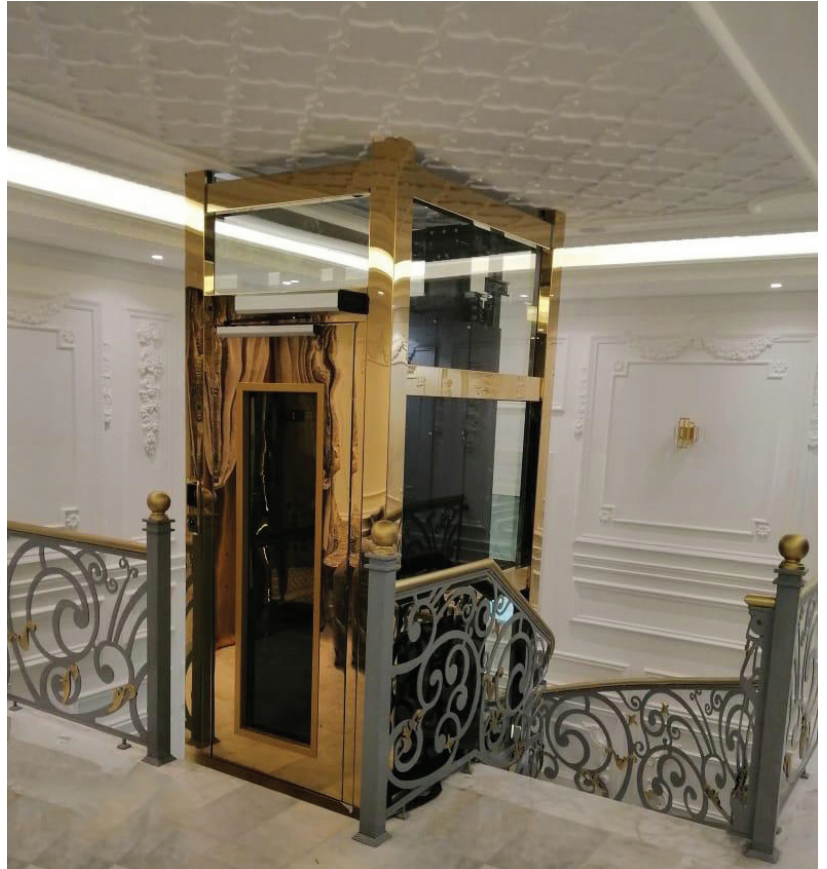





VITAL  
LIFT



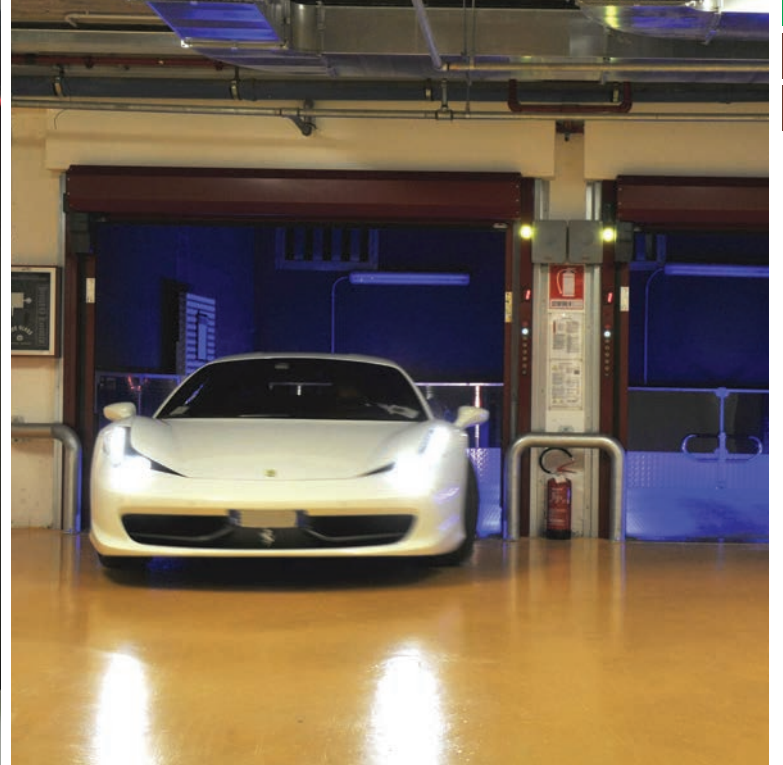

**İnsan Asansörleri (Sınıf I-II) Fonksiyonel Boyutlar / Passenger Elevators (Class I-II) Functional Dimensions**

				KONUTLAR / HOUSES				İŞYERLERİ / OFFICES					
TAŞIMA KAPASİTESİ / CAPACITY			(Kg)	320	400	630	1000	630	800	1000	1250	1600	
ANMA YÜKÜ / NOMINAL LOAD			(Kişi)	4	5	8	13	8	10	13	16	21	
KABİN ALANI / CABIN SPACE			(min)	0,79	0,98	1,45	2,15	1,45	1,73	2,15	2,57	3,245	
			(max)	0,95	1,17	1,66	2,40	1,66	2,00	2,40	2,90	3,56	
KABİN EBATLARI CABIN DIMENSIONS	Genişlik / Width	b1	(mm)	900	1100	1100	1100	1100	1350	1600	1950	1950	
	Derinlik / Depth	d1	(mm)	1000	1000	1400	2100	1400	1400	1400	1400	1750	
	Yükseklik / Height		(mm)	2200	2200	2200	2200	2200	2200	2300	2300	2300	
DURAK KAPILARI LANDING DOORS	Genişlik	b2	(mm)	700	800	800	800	800	800	1100	1100	1100	
	Yükseklik	h3	(mm)	2000	2000	2000	2000	2000	2000	2100	2100	2100	
KUYU EBATLARI SHAFT DIMENSIONS	Genişlik 1)	b3	(mm)	1400	1600	1600	1600						
	Genişlik 2)	b3	(mm)		1800	1800	1800	1800	1900	2400	2600	2600	
	Derinlik	d2	(mm)	1600	1600	1900	2600	2100	2300	2300	2300	2600	
KUYU DİBİ DERİNLİĞİ PIT	0,63m/sn	d3	(mm)	1400	1400	1400	1400	1400	1400	1400	1600	1600	
	1,00m/sn	d3	(mm)	1400	1400	1400	1400	1400	1400	1400	1600	1600	
	1,60m/sn	d3	(mm)		1600	1600	1600	1600	1600	1600	1600	1600	
	2,50m/sn	d3	(mm)			2200	2200		2200	2200	2200	2200	
EN ÜST DURAK SEVİYESİ ÜSTÜNDEKİ YÜKSEKLİK OVERHEAD	0,63m/sn	h1	(mm)	3600	3600	3600	3600	3800	3800	4200	4400	4400	
	1,00m/sn	h1	(mm)	3700	3700	3700	3700	3800	3800	4200	4400	4400	
	1,60m/sn	h1	(mm)	3800	3800	3800	3800	4000	4000	4200	4400	4400	
	2,50m/sn	h1	(mm)			5000	5000		5000	5200	5400	5400	
M A K i M A N C H I N E A R O R O M S i	ALAN SPACE	0,63m/sn	A	(m2)	6	7,5	10	12	15	15	20	22	25
		1,00m/sn	A	(m2)	6	7,5	10	12	15	15	20	22	25
		1,60m/sn	A	(m2)		10	12	14	15	15	20	22	25
		2,50m/sn	A	(m2)			14	16		18	20	22	25
	GENİŞLİK WIDTH	0,63m/sn	h1	(mm)	1600	2200	2200	2400	2500	2500	3200	3200	3200
		1,00m/sn	h1	(mm)	1600	2200	2200	2400	2500	2500	3200	3200	3200
		1,60m/sn	h1	(mm)		2200	2200	2400	2500	2500	3200	3200	3200
		2,50m/sn	h1	(mm)			2800	2800		2800	3200	3200	3200
	DERİNLİK DEPTH	0,63m/sn	d4	(mm)	3000	3200	3700	4200	3700	3700	4900	4900	5500
		1,00m/sn	d4	(mm)	3000	3200	3700	4200	3700	3700	4900	4900	5500
		1,60m/sn	d4	(mm)		3200	3700	4200	3700	3700	4900	4900	5500
		2,50m/sn	d4	(mm)			3700	4200		3700	4900	4900	5500
YÜKSEKLİK HEIGHT	0,63m/sn	h2	(mm)	2000	2000	2000	2000	2200	2200	2400	2400	2800	
	1,00m/sn	h2	(mm)	2000	2000	2000	2000	2200	2200	2400	2400	2800	
	1,60m/sn	h2	(mm)		2200	2200	2200	2200	2200	2400	2400	2800	
	2,50m/sn	h2	(mm)			2600	2600		2800	2800	2800	2800	

\*Sağa veya sola toplanan teleskopik kapılı asansörler için / For telescopic elevators with doors opening to the right and left

\*\*Merkezden açılan kapılı asansörler için / For elevators with central opening

\*\*\*320 ve 400 Kg. taşıma kapasiteli asansör. er engelli kişilerin tekerlekli sandalyede asansörü kullanmaları için uygun değildir / Elevators with a load capacity of 320 and 420 kg are not suitable for use by people with disabilities in a wheelchair

**Hasta Asansörleri (sınıf I-II) Fonksiyonel Boyutlar / Patient Lifts (class I-II) Functional Dimensions**

TAŞIMA KAPASİTESİ / Capacity			(Kg)	1600	2000	2500
KABİN ALANI / Cabin space			(min)	3,245	3,82	4,625
			(max)	3,56	4,2	5
KABİN EBATLARI Cabinet Dimensions	Genişlik / Width	b1	(mm)	1400	1500	1800
	Derinlik / Depth	d1	(mm)	2400	2700	2700
	Yükseklik / Height		(mm)	2300	2300	2300
DURAK KAPILARI Stall Doors	Genişlik / Width	b2	(mm)	1300	1300	1300
	Yükseklik / Height	h3	(mm)	2100	2100	2100
KUYU EBATLARI Pit dimensions	Genişlik / Width	b3	(mm)	2400	2400	2700
	Derinlik / Depth	d2	(mm)	3000	3200	3300
KUYU DİBİ DERİNLİĞİ Elevator Pit Bottom	Vn=0,63m/sn	d3	(mm)	1600	1600	1800
	Vn=1,00m/sn	d3	(mm)	1700	1700	1900
	Vn=1,60m/sn	d3	(mm)	1900	1900	2100
	Vn=2,50m/sn	d3	(mm)	2500	2500	2500
EN ÜST DURAK SEVİYESİ ÜSTÜNDEKİ YÜKSEKLİK Height Above the Highest Stall Level	Vn=0,63m/sn	h1	(mm)	4400	4400	4400
	Vn=1,00m/sn	h1	(mm)	4400	4400	4600
	Vn=1,60m/sn	h1	(mm)	4400	4400	4600
	Vn=2,50m/sn	h1	(mm)	5400	5400	5600
MAKİNA DAİRESİ Engine Room	ALAN / Space	A	(m <sup>2</sup> )	25	27	29
	GENİŞLİK / Width	b4	(mm)	3200	3200	3500
	DERİNLİK / Depth	d4	(mm)	5500	5800	5800
	YÜKSEKLİK / Height	h2	(mm)	2800	2800	2800

**Yük Asansörleri (sınıf IV) Fonksiyonel Boyutlar / Load Elevators (Class IV) Functional Dimensions**

TAŞIMA KAPASİTESİ / Carriage Quality			(Kg)	630	1000	1600	2000
KABİN EBATLARI Cabinet Dimensions	Genişlik / Width	b1	(mm)	1100	1300	1500	1500
	Derinlik / Depth	d1	(mm)	1400	1750	2250	2700
	Yükseklik / Height		(mm)	2200	2300	2200	2200
DURAK KAPILARI Stall Doors	Derinlik / Depth	b2	(mm)	1100	1300	1500	1500
	Yükseklik / Height	h3	(mm)	2100	2100	2100	2100
KUYU EBATLARI Pit Dimensions	Genişlik / Width	b3	(mm)	2100	2400	2700	2700
	Derinlik / Depth	d2	(mm)	1900	2300	2800	3200
KUYU DİBİ DERİNLİĞİ Elevator Pit Bottom	V<1,00m/sn	d3	(mm)	1500	1500	1700	1700
EN ÜST DURAK SEVİYESİ ÜSTÜNDEKİ YÜKSEKLİK Height Above the Highest Stall Level	V<1,00m/sn	h1	(mm)	4100	4100	4300	4300
MAKİNA DAİRESİ Engine Room	ALAN / Space	A	(mm)	12	14	18	20
	GENİŞLİK / Width	b4	(mm)	2800	3100	3400	3400
	DERİNLİK / Depth	d4	(mm)	3500	3800	4500	4900
	YÜKSEKLİK / Height	h2	(mm)	2200	2200	2400	2400

**Servis Asansörleri (sınıf V) Fonksiyonel Boyutlar / Service Elevators (Class V) Functional Dimensions**

TAŞIMA KAPASİTESİ / Carriage Quality			(Kg)	40	100	250
KABİN EBATLARI Cabinet Dimensions	Genişlik / Width	b1	(mm)	600	800	1000
	Derinlik / Depth	d1	(mm)	600	850	1000
	Yükseklik / Height		(mm)	800	800	1200
KUYU EBATLARI Pit Dimensions	Genişlik / Width	b3	(mm)	900	1100	1500
	Derinlik / Depth	d2	(mm)	800	1000	1200





# VİTAL GRUP

COMPLETE ELEVATOR SYSTEMS

Factory: 3.Organize Sanayi Bölgesi Büyükkayacık Mh. 9.Sk. No:31 Selçuklu/Konya  
T: +90 332 345 13 85 F: +90 332 345 13 86

Istanbul Office: Şerifali Mahallesi Türker Caddesi No: 42 Ümraniye / İstanbul  
T: +90 216 314 30 35 F: +90 216 314 30 36

bilgi@vitalasansor.com | export@vitalasansor.com | satis@vitalasansor.com  
www.vitalasansor.com | www.vilift.com.tr

Vİ PAR

Vİ DOOR

Vİ PANO

Vİ MAK

Vİ LIFT

SlimLIFT NormLIFT